

Thermally-Enhanced High Power RF LDMOS FET 45 W, 2.62 – 2.68 GHz

Description

The PTFA260451E is a thermally-enhanced 45-watt, internally-matched *GOLDMOS*® FET intended for CDMA2000, Super3G (3GPP TSG RAN), and WiMAX applications from 2.62 to 2.68 GHz. Thermally-enhanced packaging provide the coolest operation available. Full gold metallization ensures excellent device lifetime and reliability.

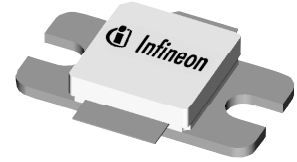

PTFA260451E
Package H-30265-2

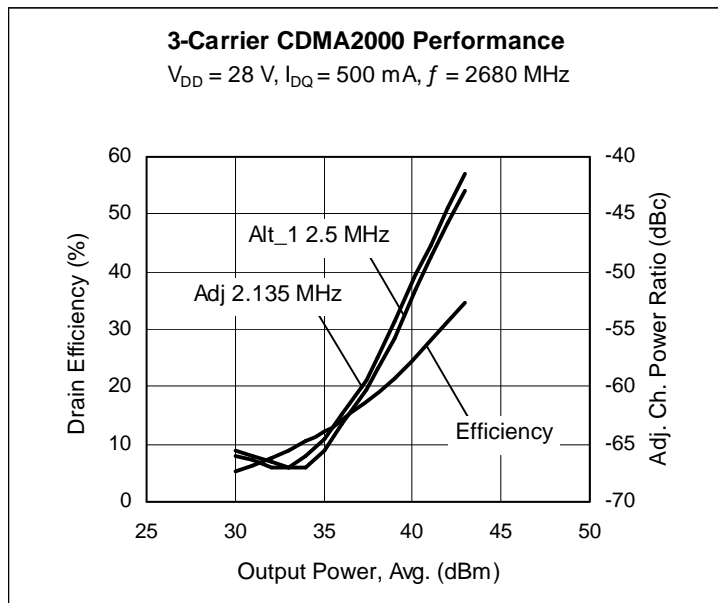

Features

- Lead-free, RoHS-compliant and thermally-enhanced packaging
- Internal matching for wideband performance
- Typical three-carrier CDMA2000 performance
 - Average output power = 10 W
 - Gain = 14 dB
 - Efficiency = 24%
 - ACPR = -52 dBc
- Typical CW performance
 - Output power at P-1dB = 50 W
 - Efficiency = 46%
- Integrated ESD protection: Human Body Model, Class 2 (minimum)
- Excellent thermal stability
- Low HCI Drift
- Capable of handling 10:1 VSWR @ 28 V, 45 W (CW) output power

RF Performance

CDMA Measurements (not subject to production test—verified by design/characterization in Infineon test fixture)

$V_{DD} = 28\text{ V}$, $I_{DQ} = 500\text{ mA}$, $P_{OUT} = 10\text{ W AVG}$, $f = 2680\text{ MHz}$

Characteristic	Symbol	Min	Typ	Max	Unit
Adjacent Channel Power Ratio	ACPR	—	-45	—	dBc
Gain	G_{ps}	—	14	—	dB
Drain Efficiency	η_D	—	24	—	%

All published data at $T_{CASE} = 25^\circ\text{C}$ unless otherwise indicated

ESD: Electrostatic discharge sensitive device—observe handling precautions!

RF Performance (cont.)

Two-tone Measurements (tested in Infineon test fixture)

 $V_{DD} = 28\text{ V}$, $I_{DQ} = 500\text{ mA}$, $P_{OUT} = 45\text{ W PEP}$, $f = 2680\text{ MHz}$, tone spacing = 1 MHz

Characteristic	Symbol	Min	Typ	Max	Unit
Gain	G_{ps}	14.0	15	—	dB
Drain Efficiency	η_D	36	37	—	%
Intermodulation Distortion	IMD	—	-30	-28	dBc

DC Characteristics

Characteristic	Conditions	Symbol	Min	Typ	Max	Unit
Drain-Source Breakdown Voltage	$V_{GS} = 0\text{ V}$, $I_D = 10\text{ mA}$	$V_{(BR)DSS}$	65	—	—	V
Drain Leakage Current	$V_{DS} = 28\text{ V}$, $V_{GS} = 0\text{ V}$	I_{DSS}	—	—	1.0	μA
	$V_{DS} = 63\text{ V}$, $V_{GS} = 0\text{ V}$	I_{DSS}	—	—	10.0	μA
On-State Resistance	$V_{GS} = 10\text{ V}$, $V_{DS} = 0.1\text{ V}$	$R_{DS(on)}$	—	0.16	—	Ω
Operating Gate Voltage	$V_{DS} = 28\text{ V}$, $I_{DQ} = 500\text{ mA}$	V_{GS}	2.0	2.5	3	V
Gate Leakage Current	$V_{GS} = 10\text{ V}$, $V_{DS} = 0\text{ V}$	I_{GSS}	—	—	1.0	μA

Maximum Ratings

Parameter	Symbol	Value	Unit
Drain-Source Voltage	V_{DSS}	65	V
Gate-Source Voltage	V_{GS}	-0.5 to +12	V
Junction Temperature	T_J	200	$^{\circ}\text{C}$
Total Device Dissipation	P_D	199	W
		Above 25 $^{\circ}\text{C}$ derate by	1.14
Storage Temperature Range	T_{STG}	-40 to +150	$^{\circ}\text{C}$
Thermal Resistance ($T_{CASE} = 70^{\circ}\text{C}$, 45 W CW)	$R_{\theta JC}$	0.88	$^{\circ}\text{C/W}$

Ordering Information

Type and Version	Package Outline	Package Description	Marking
PTFA260451E V1	H-30265-2	Thermally-enhanced slotted flange, single-ended	PTFA260451E

Typical Performance (data taken in production test fixture)

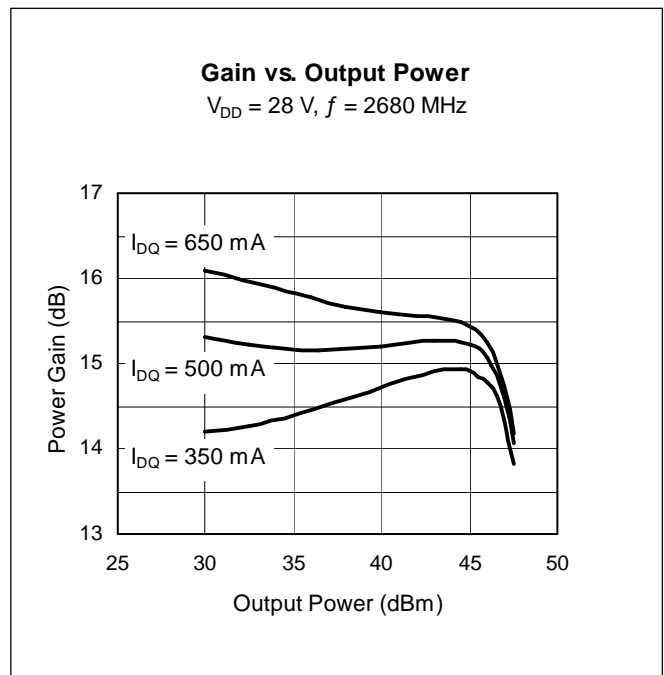
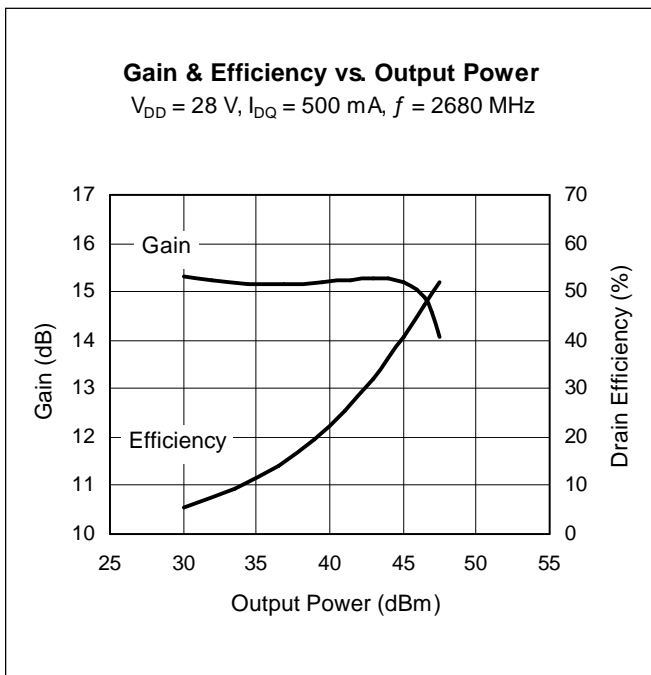
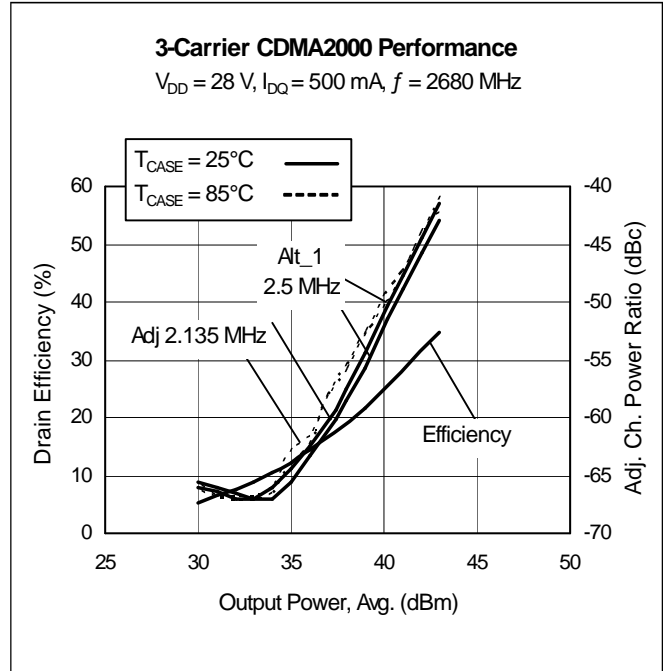
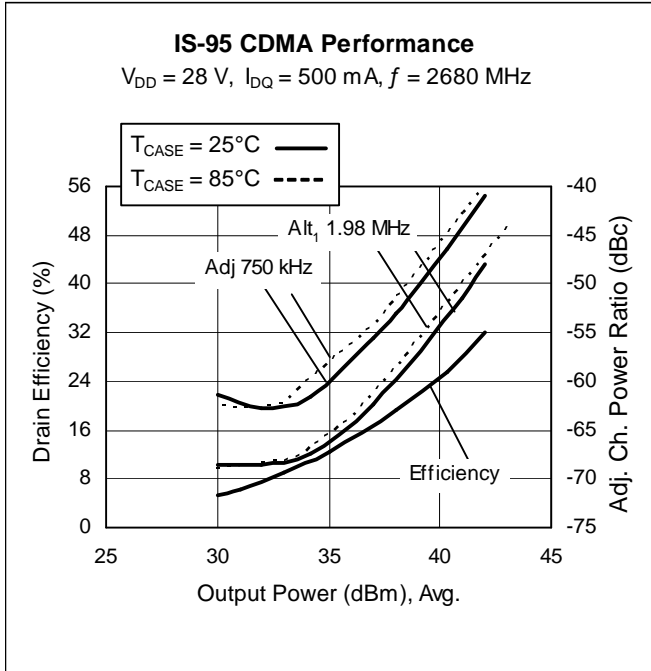

Typical Performance (cont.)

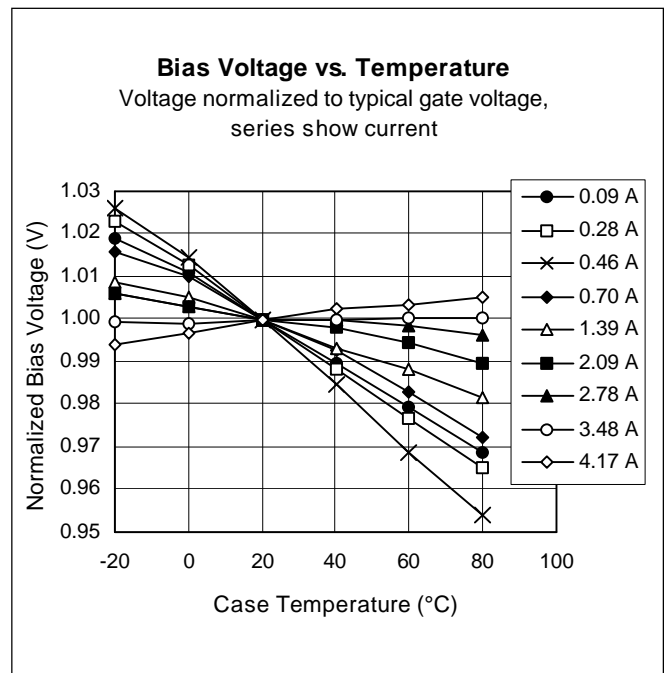
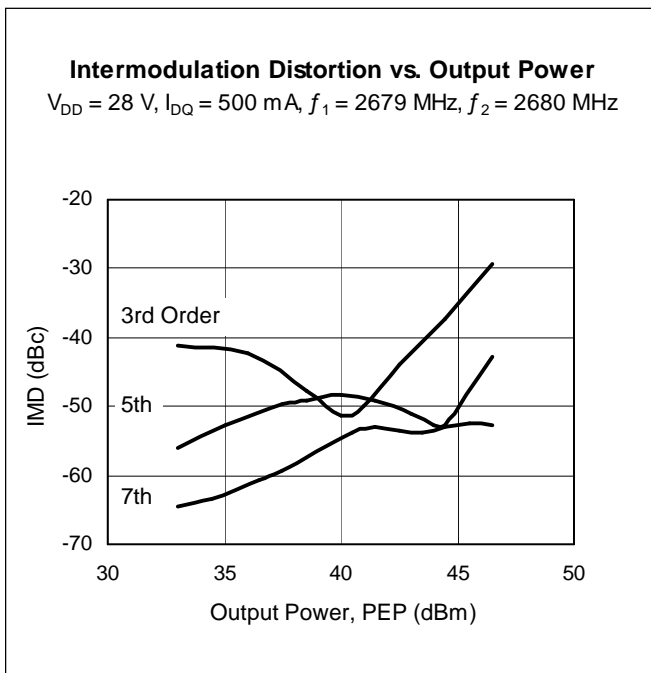
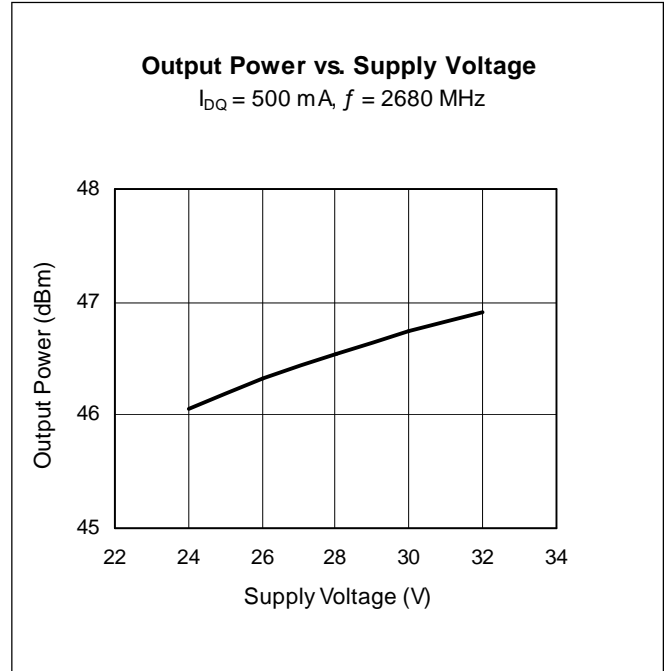
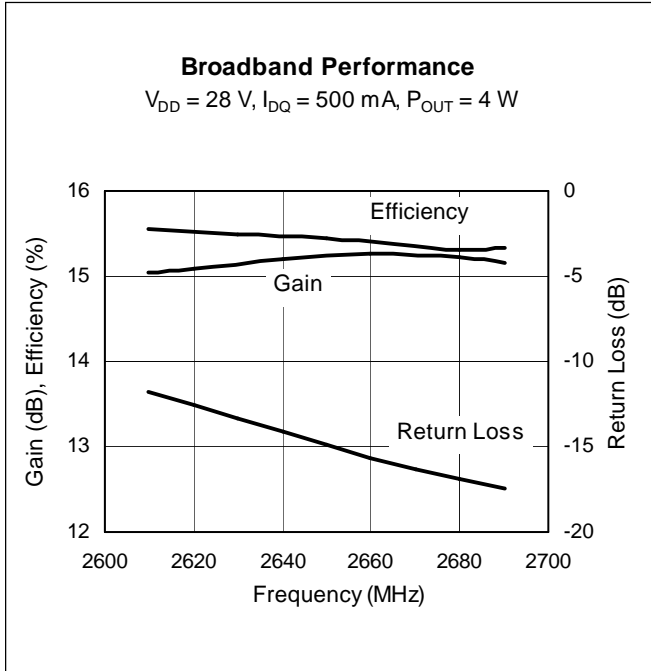

Typical WiMAX Performance

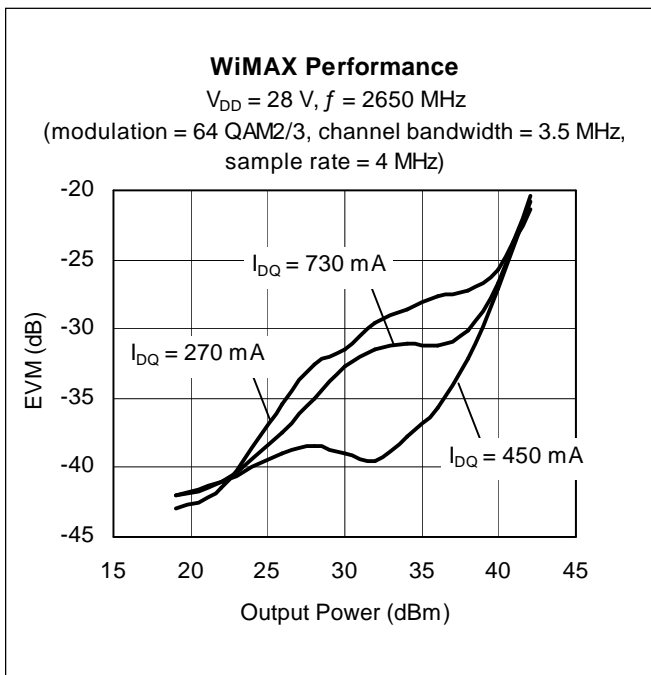
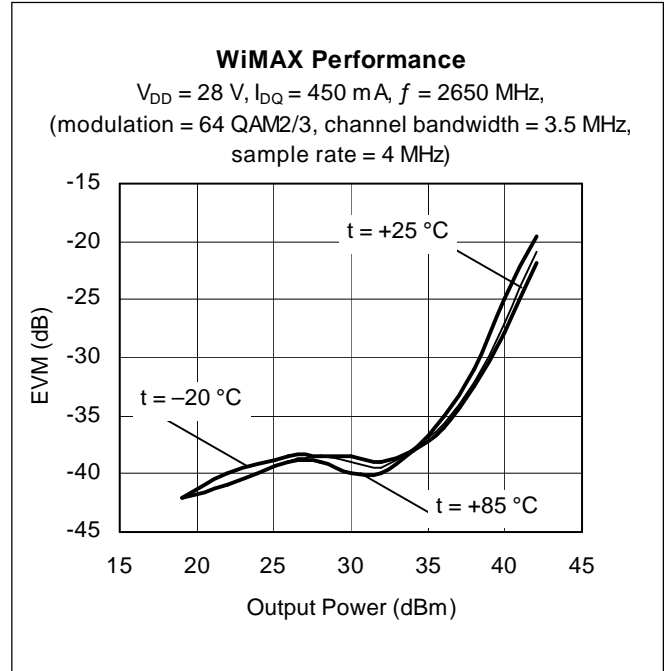
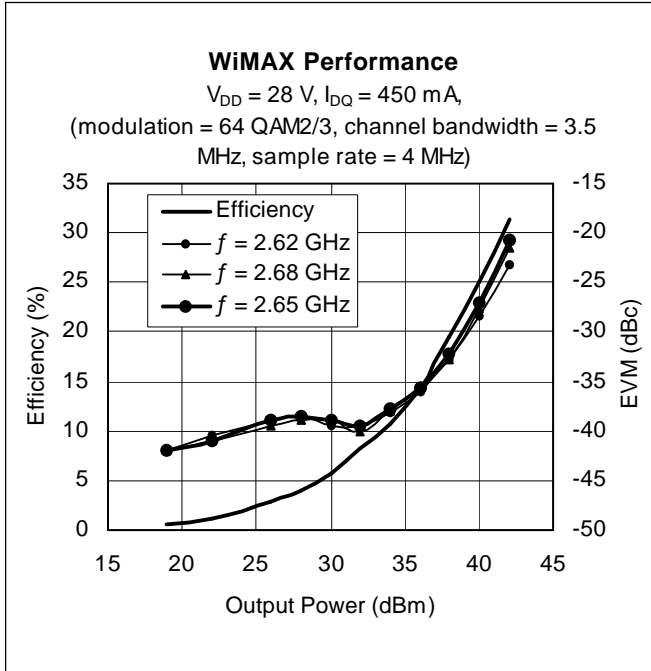

Broadband Circuit Impedance

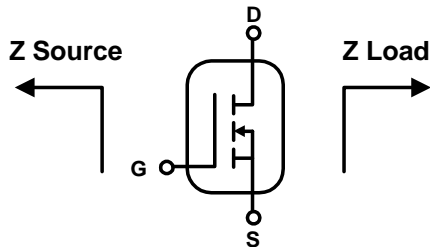

Frequency MHz	Z Source W		Z Load W	
	R	jX	R	jX
2600	19.5	-1.5	7.5	-0.7
2620	17.0	-2.1	7.3	-0.5
2650	18.6	0.8	7.0	-0.3
2680	19.0	-0.8	6.8	0.1
2700	18.0	-3.0	6.7	0.2

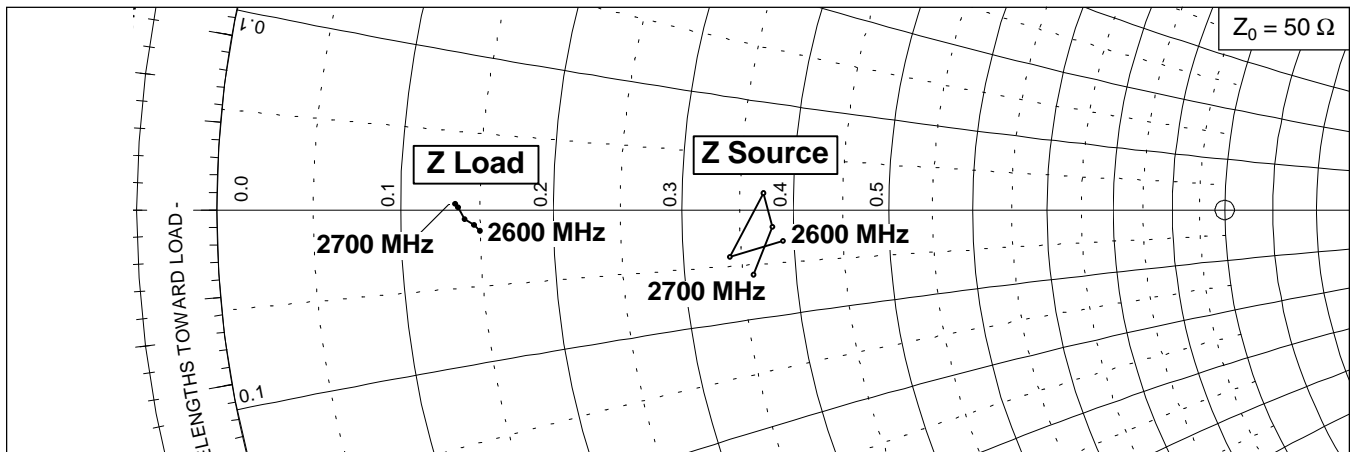

See next page for reference circuit information

Reference Circuit

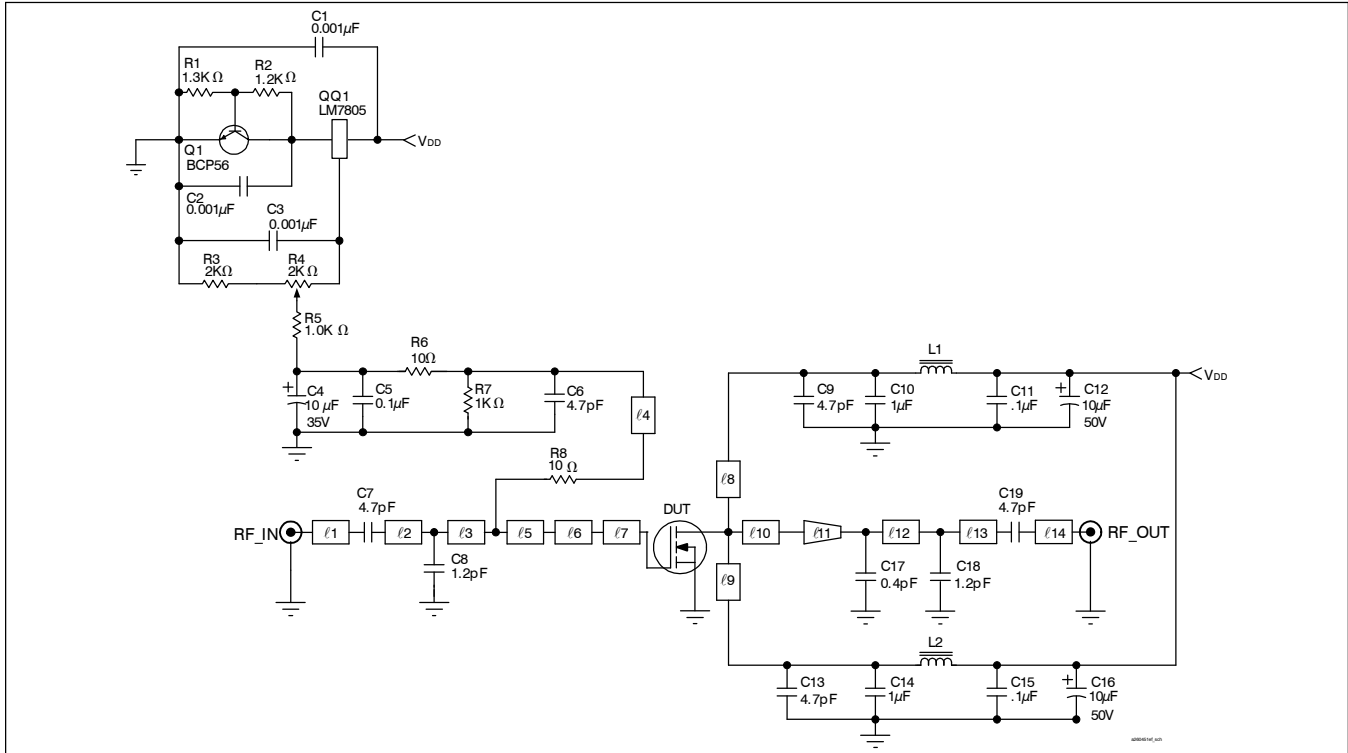

Reference circuit schematic for $f = 2680$ MHz

Circuit Assembly Information

DUT	PTFA260451E	LDMOS Transistor	
PCB	0.76 mm [.030"] thick, $\epsilon_r = 4.5$	Rogers TMM4	2 oz. copper

Microstrip	Electrical Characteristics at 2680 MHz ¹	Dimensions: L x W (mm)	Dimensions: L x W (in.)
l_1	0.130 λ , 50.0 Ω	7.87 x 1.47	0.310 x 0.058
l_2	0.061 λ , 44.0 Ω	3.68 x 1.83	0.145 x 0.072
l_3	0.065 λ , 44.0 Ω	3.91 x 1.83	0.154 x 0.072
l_4	0.299 λ , 62.0 Ω	18.44 x 1.02	0.726 x 0.040
l_5	0.018 λ , 44.0 Ω	1.09 x 1.83	0.043 x 0.072
l_6	0.029 λ , 15.0 Ω	1.65 x 7.62	0.065 x 0.300
l_7	0.077 λ , 12.5 Ω	4.32 x 9.45	0.170 x 0.372
l_8	0.234 λ , 55.0 Ω	14.33 x 1.27	0.564 x 0.050
l_9	0.218 λ , 55.0 Ω	13.36 x 1.27	0.526 x 0.050
l_{10}	0.050 λ , 6.6 Ω	2.74 x 19.10	0.108 x 0.752
l_{11} (taper)	0.080 λ , 6.6 Ω / 50.0 Ω	4.90 x 19.10 / 1.32	0.193 x 0.752 / 0.052
l_{12}	0.053 λ , 50.0 Ω	3.25 x 1.32	0.128 x 0.052
l_{13}	0.133 λ , 50.0 Ω	8.13 x 1.32	0.320 x 0.052
l_{14}	0.070 λ , 50.0 Ω	4.27 x 1.32	0.168 x 0.052

¹Electrical characteristics are rounded.

Reference Circuit (cont.)

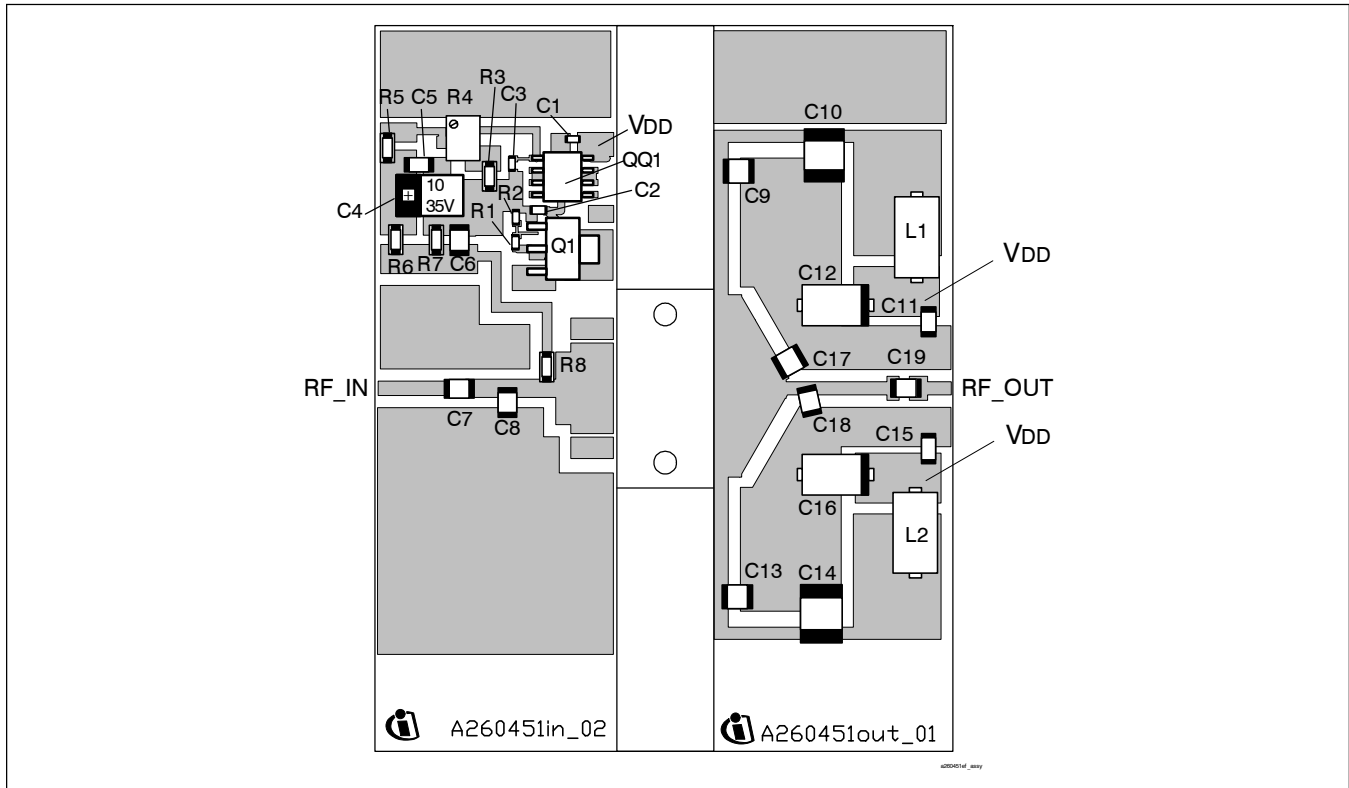

Reference circuit assembly diagram* (not to scale)

Component	Description	Suggested Manufacturer	P/N or Comment
C1, C2, C3	Capacitor, 0.001 μ F	Digi-Key	PCC1772CT-ND
C4	Tantalum capacitor, 10 μ F, 35 V	Digi-Key	PCS6106TR-ND
C5, C11, C15	Capacitor, 0.1 μ F	Digi-Key	PCC104BCT-ND
C6, C7, C9, C13, C19	Ceramic capacitor, 4.7 pF	ATC	100B 4R7
C8, C18	Ceramic capacitor, 1.2 pF	ATC	100B 1R2
C10, C14	Capacitor, 1 μ F	ATC	920C105KW
C12, C16	Tantalum capacitor, 10 μ F, 50 V	Garrett Electronics	TPSE106K050R0400
C17	Ceramic capacitor, 0.4 pF	ATC	100B 0R4
Q1	Transistor	Infineon Technologies	BCP56
QQ1	Voltage regulator	National Semiconductor	LM7805
R1	Chip resistor, 1.3 k-ohms	Digi-Key	P1.3KGCT-ND
R2	Chip resistor, 1.2 k-ohms	Digi-Key	P1.2KGCT-ND
R3	Chip resistor, 2 k-ohms	Digi-Key	P2.0KECT-ND
R4	Potentiometer, 2 k-ohms	Digi-Key	3224W-202ETR-ND
R5, R7	Chip resistor, 1 k-ohms	Digi-Key	P1.0KECT-ND
R6, R8	Chip resistor, 10 ohms	Digi-Key	P10ECT-ND
L1, L2	Ferrite	Philips	BDS46/3.8.8-452

*Gerber Files for this circuit available on request

Page	Subjects (major changes since last revision)
All	Remove references to alternate products.

We Listen to Your Comments

Any information within this document that you feel is wrong, unclear or missing at all? Your feedback will help us to continuously improve the quality of this document. Please send your proposal (including a reference to this document) to:

highpowerRF@infineon.com

To request other information, contact us at:
+1 877 465 3667 (1-877-GO-LDMOS) USA
or +1 408 776 0600 International

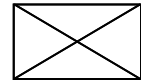

GOLDMOS® is a registered trademark of Infineon Technologies AG.

Edition 2008-03-04

Published by
Infineon Technologies AG
81726 Munich, Germany

© 2004 Infineon Technologies AG
All Rights Reserved.

Legal Disclaimer

The information given in this document shall in no event be regarded as a guarantee of conditions or characteristics. With respect to any examples or hints given herein, any typical values stated herein and/or any information regarding the application of the device, Infineon Technologies hereby disclaims any and all warranties and liabilities of any kind, including without limitation, warranties of non-infringement of intellectual property rights of any third party.

Information

For further information on technology, delivery terms and conditions and prices, please contact the nearest Infineon Technologies Office (www.infineon.com/rfpower).

Warnings

Due to technical requirements, components may contain dangerous substances. For information on the types in question, please contact the nearest Infineon Technologies Office.

Infineon Technologies components may be used in life-support devices or systems only with the express written approval of Infineon Technologies, if a failure of such components can reasonably be expected to cause the failure of that life-support device or system or to affect the safety or effectiveness of that device or system. Life support devices or systems are intended to be implanted in the human body or to support and/or maintain and sustain and/or protect human life. If they fail, it is reasonable to assume that the health of the user or other persons may be endangered.